

TASCAM

D01237920D

US-366

USB Audio Interface

OWNER'S MANUAL

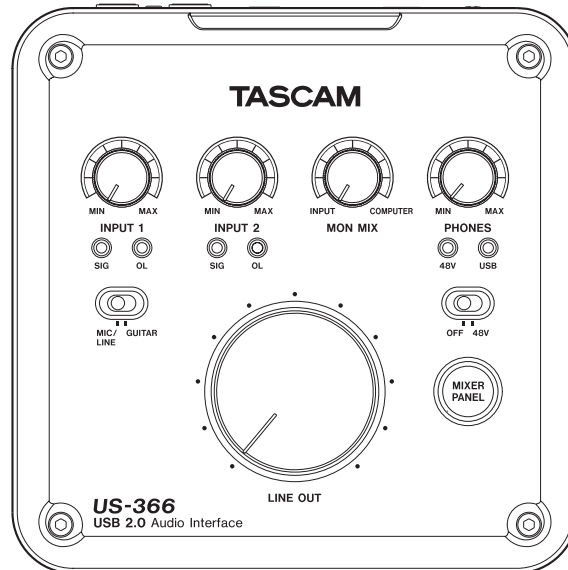

Before connecting this unit to a computer, the dedicated driver must be installed on the computer.

IMPORTANT SAFETY PRECAUTIONS

WARNING: TO PREVENT FIRE OR SHOCK HAZARD, DO NOT EXPOSE THIS APPLIANCE TO RAIN OR MOISTURE.

■ For U.S.A

TO THE USER

This equipment has been tested and found to comply with the limits for a Class B digital device, pursuant to Part 15 of the FCC Rules. These limits are designed to provide reasonable protection against harmful interference in a residential installation. This equipment generates, uses, and can radiate radio frequency energy and, if not installed and used in accordance with the instruction manual, may cause harmful interference to radio communications. However, there is no guarantee that interference will not occur in a particular installation. If this equipment does cause harmful interference to radio or television reception, which can be determined by turning the equipment off and on, the user is encouraged to try to correct the interference by one or more of the following measures.

- Reorient or relocate the receiving antenna.
- Increase the separation between the equipment and receiver.
- Connect the equipment into an outlet on a circuit different from that to which the receiver is connected.
- Consult the dealer or an experienced radio/TV technician for help.

CAUTION

Changes or modifications to this equipment not expressly approved by TEAC CORPORATION for compliance could void the user's authority to operate this equipment.

Declaration of Conformity

Model Number : US-366
Trade Name : TASCAM
Responsible party: TEAC AMERICA, INC.
Address : 7733 Telegraph Road, Montebello, California, U.S.A.

Telephone number: 1-323-726-0303

This device complies with Part 15 of the FCC Rules. Operation is subject to the following two conditions: (1) this device may not cause harmful interference, and (2) this device must accept any interference received, including interference that may cause undesired operation.

This appliance has a serial number located on the rear panel. Please record the model number and serial number and retain them for your records.

Model number _____

Serial number _____

■ For European Customers

Disposal of electrical and electronic equipment

- All electrical and electronic equipment should be disposed of separately from the municipal waste stream via collection facilities designated by the government or local authorities.
- By disposing of electrical and electronic equipment correctly, you will help save valuable resources and prevent any potential negative effects on human health and the environment.
- Improper disposal of waste electrical and electronic equipment can have serious effects on the environment and human health because of the presence of hazardous substances in the equipment.
- The Waste Electrical and Electronic Equipment (WEEE) symbol, which shows a wheeled bin that has been crossed out, indicates that electrical and electronic equipment must be collected and disposed of separately from household waste.



- Return and collection systems are available to end users. For more detailed information about the disposal of old electrical and electronic equipment, please contact your city office, waste disposal service or the shop where you purchased the equipment.

■ For Canada

THIS CLASS B DIGITAL APPARATUS COMPLIES WITH CANADIAN ICES-003.
CET APPAREIL NUMÉRIQUE DE LA CLASSE B EST CONFORME À LA NORME NMB-003 DU CANADA.

DECLARATION OF CONFORMITY

We, TEAC EUROPE GmbH, Bahnstrasse 12, 65205 Wiesbaden-Erbenheim, Germany declare in own responsibility, the TEAC product described in this manual is in compliance with the corresponding technical standards.



IMPORTANT SAFETY INSTRUCTIONS

- 1 Read these instructions.
- 2 Keep these instructions.
- 3 Heed all warnings.
- 4 Follow all instructions.
- 5 Do not use this apparatus near water.
- 6 Clean only with dry cloth.
- 7 Do not block any ventilation openings. Install in accordance with the manufacturer's instructions.
- 8 Do not install near any heat sources such as radiators, heat registers, stoves, or other apparatus (including amplifiers) that produce heat.
- 9 Do not defeat the safety purpose of the polarized or grounding-type plug. A polarized plug has two blades with one wider than the other. A grounding type plug has two blades and a third grounding prong. The wide blade or the third prong are provided for your safety. If the provided plug does not fit into your outlet, consult an electrician for replacement of the obsolete outlet.
- 10 Protect the power cord from being walked on or pinched particularly at plugs, convenience receptacles, and the point where they exit from the apparatus.
- 11 Only use attachments/accessories specified by the manufacturer.
- 12 Use only with the cart, stand, tripod, bracket, or table specified by the manufacturer, or sold with the apparatus. When a cart is used, use caution when moving the cart/apparatus combination to avoid injury from tip-over.



- 13 Unplug this apparatus during lightning storms or when unused for long periods of time.
- 14 Refer all servicing to qualified service personnel. Servicing is required when the apparatus has been damaged in any way, such as power-supply cord or plug is damaged, liquid has been spilled or objects have fallen into the apparatus, the apparatus has been exposed to rain or moisture, does not operate normally, or has been dropped.

- The apparatus draws nominal non-operating power from the AC outlet with its POWER or STANDBY/ON switch not in the ON position.
- The mains plug is used as the disconnect device, the disconnect device shall remain readily operable.
- Caution should be taken when using earphones or headphones with the product because excessive sound pressure (volume) from earphones or headphones can cause hearing loss.
- If you are experiencing problems with this product, contact TEAC for a service referral. Do not use the product until it has been repaired.

CAUTION

- Do not expose this apparatus to drips or splashes.
- Do not place any objects filled with liquids, such as vases, on the apparatus.
- Do not install this apparatus in a confined space such as a book case or similar unit.
- The apparatus should be located close enough to the AC outlet so that you can easily grasp the power cord plug at any time.
- If the product uses batteries (including a battery pack or installed batteries), they should not be exposed to sunshine, fire or excessive heat.
- CAUTION for products that use replaceable lithium batteries: there is danger of explosion if a battery is replaced with an incorrect type of battery. Replace only with the same or equivalent type.

Contents

1 – Introduction5

- Main features5
- Conventions used in this manual5
- Trademarks6
- Cautions on installation6
- Beware of condensation6
- Using the TEAC Global Site6
- User registration6
- Cleaning the unit6

2 – Names and Functions of Parts7

- Top panel.....7
- Rear panel9

3 – Installation 11

- System requirements..... 11
 - Windows..... 11
 - Mac OS X..... 11
- Installing the driver..... 11
 - Installing the driver for Windows 11
 - Installing the driver for Mac OS X 12
- Frequently asked installation questions and answers (FAQ) 14
- Improving computer performance..... 14

4 – Connections..... 15

- USB connections..... 16
- Audio connections..... 16
 - Microphones..... 16
 - Guitars 16
 - Sound module/MD/CD etc. (digital connection) 17
 - Connecting keyboards, drum machines, sound modules, cassette/MD/CD players and other analog line level devices..... 17
 - Analog record player 17
 - Monitor speakers..... 17
 - Headphones..... 17

- Foot switch 17

5 – Using the Mixer Panel 18

- Mixer panel settings..... 18
 - “INTERFACE” page 18
 - “MIXER” page 19
 - “EFFECTS” page 22
 - Resetting settings to their default values 25

6 – Application Guide 26

- Windows Media Player 26
- Mac OS X and iTunes..... 26
 - Using Audio MIDI setup in OS X Mavericks (10.9) or later 27

7 – Troubleshooting 28

8 – Specifications 30

- Ratings..... 30
- Analog audio inputs and outputs 30
 - Analog audio inputs..... 30
 - Analog audio outputs..... 30
- Digital audio inputs 30
- Digital audio outputs 30
- Control I/O..... 31
- Audio performance 31
- Computer requirements 31
 - Windows..... 31
 - Mac OS X..... 31
 - Supported audio drivers..... 31
 - Supported remote control protocol..... 31
- Audio flow diagrams 33

■ For China

 “環境保護使用年限”

产品有毒有害物质或元素的名称及含量

机种：US-366		有毒有害物质或元素					
	品名	铅 (Pb)	汞 (Hg)	镉 (Cd)	六价铬 (Cr(VI))	多溴联苯 (PBB)	多溴二苯醚 (PBDE)
1	CHASSIS 部份	○	○	○	○	○	○
2	PCB Assy 部份	×	○	○	○	○	○
3	线材部份	○	○	○	○	○	○
4	附属品部份	○	○	○	○	○	○
5	SEAL 部份	○	○	○	○	○	○
6	包装部份	○	○	○	○	○	○

○：表示该有毒有害物质在该部件所有均质材料中的含量均在 GB/T26572-2011 标准规定的限量要求以下。
 ×：表示该有毒有害物质至少在该部件的某一均质材料中的含量超出 GB/T26572-2011 标准规定的限量要求。
 (针对现在代替技术困难的电子部品及合金中的铅)

Thank you for your purchase of the TASCAM US-366 USB Audio Interface.

Before connecting and using the unit, please take time to read this manual thoroughly to ensure you understand how to properly set up and connect the unit, as well as the operation of its many useful and convenient functions. After you have finished reading this manual, please keep it in a safe place for future reference.

You can also download the Owner's Manual from the TEAC Global Site (<http://teac-global.com/>).

If any data is lost from another device (hard disk, optical disc, etc.) in the same system where this unit is used, TASCAM will bear no responsibility for its recovery, nor will it provide any compensation for such loss.

Main features

- US-366 is a 24-bit/192kHz USB2.0 audio interface with the DSP mixer and built-in effects that supports up to 6 channels (4 analog and 2 digital*) of simultaneous output depending on the **LINE I/O** switch setting on its bottom panel (*2 analog and 2 digital if sampling frequency is 176.4/192 kHz)
- Powered by USB bus power, increasing its portability
- TASCAM original High Definition Discrete Architecture (HDDA) microphone preamps provide high-quality recording inputs
- Can supply 48V phantom power to 2 mic inputs
- 2 XLR mic inputs (balanced), 2 standard jack inputs (balanced/unbalanced) and RCA pin jack inputs (unbalanced)
- One standard jack (**1/L**) can be switched to allow direct connection of an electric guitar/bass or similar instrument
- Independent volume knobs for each mic/line input (**INPUT 1** and **INPUT 2**)
- Independent input signal and overload indicators for both **INPUT 1** and **INPUT 2** channels
- Onboard digital mixer with switchable mode enables advanced mixing according to the application
- Dynamics effects that can be used on inputs and send effects that use a send bus are built-in (fully usable at 44.1/48 kHz sampling frequencies and with some limitations at 88.2/96 kHz)
- Direct monitoring function enables input monitoring with little delay
- **MON MIX** knob allows the balance between the input signals and the output from the computer to be adjusted for monitoring
- Stereo line outputs include standard jacks (balance) and RCA pin jacks (unbalanced)
- Dedicated volume knobs for the **1/L** and **2/R** line (**LINE OUT**) and headphone (**PHONES**) outputs
- **MIXER PANEL** button provides one touch access to the Mixer Panel on a computer
- DAW software included
- RCA pin jacks can be switched between input and output function
- Digital input connector for either a coaxial or optical cable can be activated using the **DIGITAL IN** switch
- Digital output possible simultaneously through two types of connectors (coaxial and optical)
- Remote control possible using a TASCAM RC-3F foot switch (sold separately)

A note about computer operation

If you are unsure about how to perform basic computer operations appearing in this manual, please refer to the owner's manual that came with your computer.

A dedicated driver must be installed on a computer to use this unit with it. For details about installation, see "Installing the driver" on page 11 in "3 – Installation".

Conventions used in this manual

In this manual, we use the following conventions:

- Buttons, jacks and other parts on the unit and external devices are indicated like this: **PHONES**.
- Words that appear on the computer display are shown in quotation marks like this: "US-366".
- Additional information is introduced in the styles below when needed:

TIP

These are tips about how to use the unit.

NOTE

These provide additional explanations and describe special cases.

CAUTION

Failure to follow these instructions could result in injury, damage to equipment or lost recording data, for example.

1 – Introduction

Trademarks

- TASCAM is a trademark of TEAC Corporation, registered in the U.S. and other countries.
- Microsoft, Windows, Windows Vista, and Windows Media are either registered trademarks or trademarks of Microsoft Corporation in the United States and/or other countries.
- Apple, Mac OS, OS X and iTunes are trademarks of Apple Inc., registered in the U.S. and other countries. App Store is a service mark of Apple Inc.
- ASIO is a trademark of Steinberg Media Technologies GmbH.



- Mackie and HUI are trademarks of LOUD Technologies Inc.
- Other company names, product names and logos in this document are the trademarks or registered trademarks of their respective owners.

Cautions on installation

- The unit's nominal operating temperature is between 5° and 35° C (41° – 95° F).
- Do not install in the following types of places. Doing so could degrade the sound quality and/or cause malfunctions. Places with significant vibrations or that are otherwise unstable
 - Near windows or other places exposed to direct sunlight
 - Near heaters or other extremely hot places
 - Extremely cold places
 - Places with bad ventilation or high humidity
 - Very dusty locations
- Make sure that the unit is mounted in a level position for correct operation.
- Avoid installing this unit on top of any heat-generating electrical device such as a power amplifier.

Beware of condensation

If the unit is moved from a cold to a warm place, or used after a sudden temperature change, there is a danger of condensation; vapor in the air could condense on the internal mechanism, making correct operation impossible. To prevent this, or if this occurs, let the unit sit for one or two hours at the new room temperature before using.

Using the TEAC Global Site

You can download the dedicated drivers and Owner's Manual necessary for this unit from the TEAC Global Site (<http://teac-global.com/>).

1. Open the TEAC Global Site (<http://teac-global.com/>).
2. In the TASCAM Downloads section, click the desired language to open the Downloads website page for that language.

NOTE

If the desired language does not appear, click Other Languages.

3. Click the product name in the "Search by Model Name" section to open the Downloads page for that product.
4. Select and download the dedicated drivers and Owner's Manual that are needed.

User registration

Customers in the USA, please visit the TASCAM website (<http://tascam.com/>) to register as a user online.

Cleaning the unit

To clean the unit, wipe gently with a soft dry cloth. Do not use any paint thinner, ethyl alcohol or other chemical agents to clean the unit as they could damage the surface.

2 – Names and Functions of Parts

Top panel

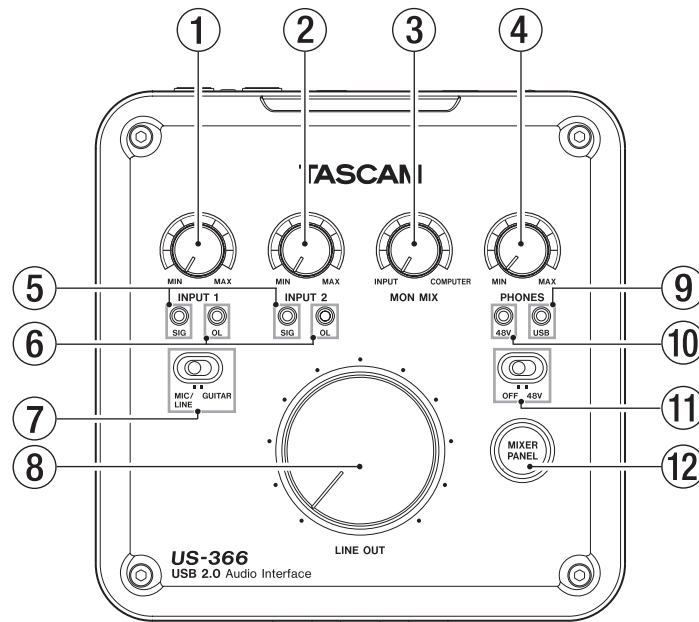

① INPUT 1 knob

Adjusts the input level from the **INPUT 1/L MIC** connector or **LINE/GUITAR** jack.

Turn all the way left to minimize the level and all the way right to maximize it.

Set so that the **OL** (overload) indicator does not light.

② INPUT 2 knob

Adjusts the input level from the **INPUT 2/R MIC** connector or **LINE** jack.

Turn all the way left to minimize the level and all the way right to maximize it.

Set so that the **OL** (overload) indicator does not light.

③ MON MIX knob

If the **MODE** switch on the bottom of the unit is set to **MULTITRACK**, adjusts the balance between the mix of signals input through this unit's input connectors and the signal mix output from the computer.

Turn all the way left toward **INPUT** to maximize the mix of signals input through this unit's input connectors (and minimize the signal mix output from the computer over USB). Turn all the way right toward **COMPUTER** to maximize the signal mix output from the computer (and minimize the mix of signals input through this unit's input connectors).

NOTE

*When the **MODE** switch on the bottom of the unit is set to **STEREO MIX**, the **MON MIX** knob is disabled (the **MON MIX** on the mixer panel screen will not move left or right even if this knob is moved).*

④ PHONES knob

Adjusts the **PHONES** jack output level.

CAUTION

*Turn the **PHONES** knob to the minimum volume before connecting headphones. Failure to do so could cause sudden loud noises and damage hearing, for example.*

⑤ SIG indicators

The **SIG** indicators light green when a signal (of at least -30 dBFS) is input to the corresponding **INPUT 1/L** or **INPUT 2/R** channel.

The **INPUT 1/L** indicator is below the **INPUT 1** knob, and the **INPUT 2/R** indicator is below the **INPUT 2** knob.

⑥ OL indicators

The **OL** indicators light red when a signal that is about to distort (-2 dBFS or higher) is input to the corresponding **INPUT 1/L** or **INPUT 2/R** channel.

The **INPUT 1/L** indicator is below the **INPUT 1** knob, and the **INPUT 2/R** indicator is below the **INPUT 2** knob.

⑦ MIC/LINE-GUITAR switch

Set this according to what is connected to the **INPUT 1/L LINE/GUITAR** jack.

Set this to **GUITAR** when connecting an electric guitar, electric bass or other instrument with high output impedance.

Set this to **MIC/LINE** when connecting an electronic instrument, audio equipment, microphone or other device.

⑧ LINE OUT knob

Adjusts the output level of the line output jacks (**OUT 1/L** and **OUT 2/R**).

⑨ USB indicator

This lights blue when the USB connection is normal.

⑩ 48V indicator

This indicator lights red when the switch just below it is set to **48V** (phantom power on).

2 – Names and Functions of Parts

⑪ 48V switch

Use this switch to supply 48V phantom power to the **INPUT 1/L** and **INPUT 2/R MIC** connectors

When this switch is set to **48V** (phantom power on), the indicator just above it lights red.

CAUTION

- *Do not connect or disconnect mics when the 48V switch is set to 48V. Doing so could cause a loud noise and might damage this unit and connected equipment.*
- *Set the 48V switch to 48V only when using a condenser microphone that requires phantom power. Setting phantom power to 48V when a dynamic mic or other mic that does not require it is connected could damage this unit and connected equipment.*
- *When using condenser mics that require phantom power and dynamic mics together, be sure to use balanced dynamic mics. Unbalanced dynamic mics cannot be used when phantom power is enabled.*

- *Supplying phantom power to some ribbon mics will break them. If you are unsure, do not supply phantom power to a ribbon mic.*
- *Set the LINE OUT and PHONES knobs to their minimum values before changing a 48V switch setting. Failure to do so could cause sudden loud noises from monitoring equipment, and this could damage equipment or harm hearing.*

⑫ MIXER PANEL button

Press this button to open and close the dedicated mixer panel window on the display of a computer connected by USB cable.

this button opens the window when it is closed and closes it when it is open.

Use the mixer panel to set the audio clock source and other operation settings, use the mixer and effects and conduct other operations.

Front panel

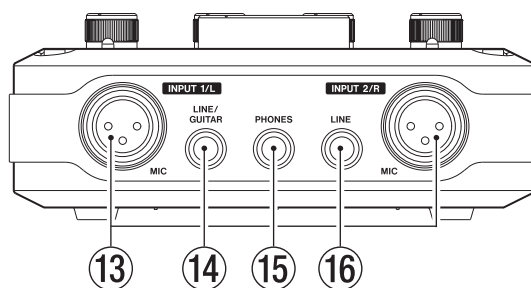

⑬ MIC connectors (balanced) [INPUT 1/L and INPUT 2/R]

These are balanced XLR mic input connectors. (1: GND, 2: HOT, 3: COLD)

⑭ LINE/GUITAR jack (balanced/unbalanced) [INPUT 1/L]

This standard TRS jack is a balanced line input connector that can also be used for guitar input.

When the **MIC/LINE-GUITAR** switch on the top of the unit is set to **GUITAR**, this functions as an unbalanced guitar input jack (tip: HOT, sleeve: GND). When the **MIC/LINE-GUITAR** switch is set to **MIC/LINE**, this functions as a balanced line input jack (tip: HOT, ring: COLD, sleeve: GND).

NOTE

INPUT 1/L and INPUT 2/R both have two input connectors (XLR and TRS). Do not input signals through both connectors for the same channel at the same time. Doing so will cause the signal input to be distorted.

⑮ PHONES jack

Use this standard stereo phones jack to connect stereo headphones. Use a plug adapter when connecting headphones with mini-plugs.

CAUTION

Turn the PHONES knob to the minimum volume before connecting headphones. Failure to do so could cause sudden loud noises and damage hearing, for example.

⑯ LINE jack (balanced) [INPUT 2/R]

This standard TRS jack is a balanced line input connector (tip: HOT, ring: COLD, sleeve: GND).

2 – Names and Functions of Parts

Rear panel

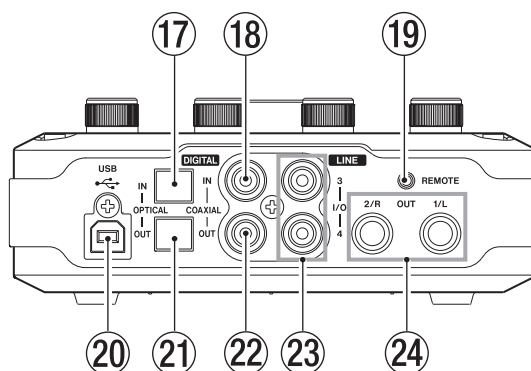

17 DIGITAL IN OPTICAL connector

This optical digital input connector complies with the S/PDIF (IEC 60958 consumer) standard.

Signals cannot be simultaneously input through this connector and the **DIGITAL IN COAXIAL** jack.

Set the **DIGITAL IN** switch on the bottom of the unit to **OPTICAL** to use this connector.

18 DIGITAL IN COAXIAL jack

This coaxial digital input connector complies with the S/PDIF (IEC 60958 consumer) standard.

Signals cannot be simultaneously input through this jack and the **DIGITAL IN OPTICAL connector**.

Set the **DIGITAL IN** switch on the bottom of the unit to **COAXIAL** to use this connector.

19 REMOTE jack

Connect a TASCAM RC-3F foot switch remote control (sold separately) to this 2.5mm TRS mini jack. When a foot switch is connected, you can operate the transport in applications that support Mackie control or HUI protocols.

20 USB port

Use the included USB cable to connect this unit with a computer (supports USB 2.0).

CAUTION

- **USB 1.1 is not supported.**
- **This is not compatible with computer Suspend (Sleep) mode. For this reason, the unit might not operate properly after a connected computer is brought out of Suspend (Sleep). In this case, disconnect the USB cable once and then reconnect it.**

21 DIGITAL OUT OPTICAL connector

This optical digital output connector complies with the S/PDIF (IEC 60958 consumer) and AES/EBU (IEC 60958 pro) standards.

22 DIGITAL OUT COAXIAL jack

This coaxial digital output connector complies with the S/PDIF (IEC 60958 consumer) and AES/EBU (IEC 60958 pro) standards.

NOTE

- *The US-366 COAXIAL IN/OUT jacks support simultaneous 24-bit /192kHz input and output.*
- *The US-366 DIGITAL IN connectors include an OPTICAL and a DIGITAL input, but they cannot both be used at the same time. Use the DIGITAL IN switch on the bottom of the unit to set which is active.*
- *The US-366 has two DIGITAL OUT connectors. Both the OPTICAL connector and the COAXIAL jack can be used simultaneously for digital output. The same signal is output from both.*

23 LINE I/O 3 and 4 jacks (unbalanced)

These RCA pin jacks can be used for analog line input or output. Use the **LINE I/O** switch on the bottom of the unit to set whether they are used for input or output.

CAUTION

When the LINE I/O switch is set to OUTPUT and the unit is operating with a 176.4/192kHz sampling frequency, regardless of the setting on the "INTERFACE" page of the Mixer Panel, the DIGITAL OUT signal will also be output from the LINE IN-OUT 3/4 jacks.

24 LINE OUT 1/L and 2/R (balanced) jacks

These standard TRS jacks are analog line outputs (tip: HOT, ring: COLD, sleeve: GND).

2 – Names and Functions of Parts

Bottom panel

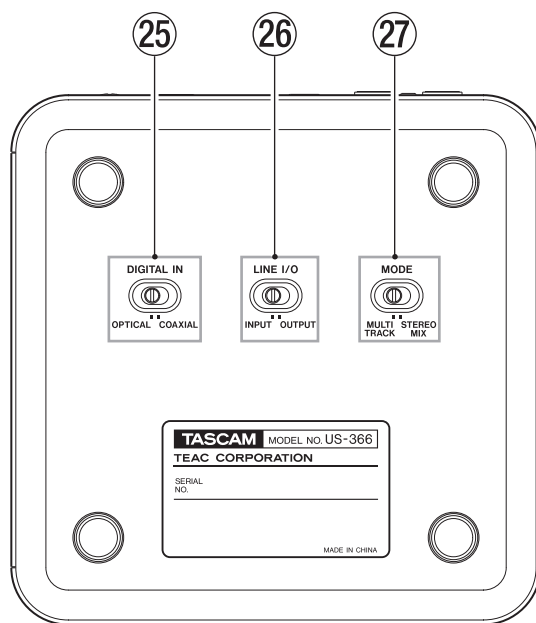

25 DIGITAL IN switch

Sets whether the **COAXIAL** or **OPTICAL** digital inputs on the rear of the unit are used.

26 LINE I/O switch

Sets whether the **LINE I/O** RCA pin jacks on the rear of the unit are used for input or output.

27 MODE switch

Sets the mixer mode according to the application.

MULTITRACK:

Use this setting when using DAW software, for example, for multitrack recording.

The signal from each input is sent independently via USB to the computer for multitrack recording. At the same time, you can mix each input sound and playback sounds from the computer in the mixer and apply effects to prepare the monitoring sound as you like.

They are output in stereo from the mixer, however, so they can be listened to using speakers or headphones.

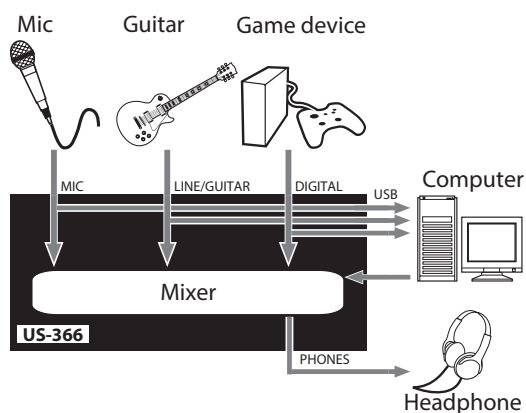

STEREO MIX:

Use this setting to broadcast or record a stereo mix for live broadcasting over the Internet or recording audio for video, for example.

All the input signals and the playback signals sent from the computer by USB are mixed to stereo and then sent to the computer and output connectors.

In addition, the mixer output can also be listened to using speakers or headphones.

For more information about multitrack and stereo mix modes, see "Audio flow diagrams" on page 33.

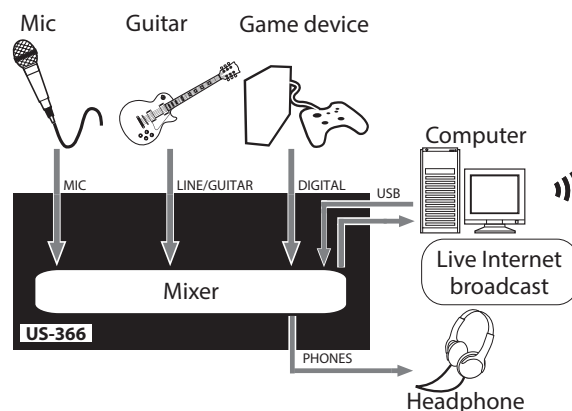

NOTE

Please be aware that when using the **STEREO MIX** mode to broadcast live over the Internet, for example, the sound could be looped, causing an echo-like repetition. Set the volume in the application that you are using to zero to avoid this.

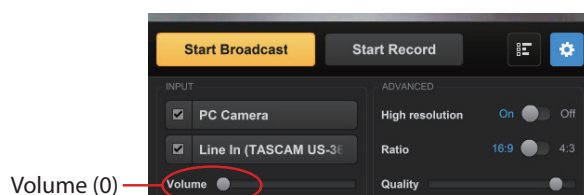

System requirements

See the TEAC Global Site (<http://teac-global.com/>) for updated information about OS compatibility.

Windows

■ Supported operating systems

Windows 10 32-bit/64-bit

Windows 8.1 32-bit/64-bit

Windows 8.0 32-bit/64-bit

Windows 7 32-bit SP1 or later/64-bit SP1 or later

Windows XP 32-bit SP3 or later/64-bit SP2 or later

(Windows Vista are not supported)

■ Supported computer systems

Windows compatible computer with a USB 2.0 port

■ CPU/clock speed

Dual core processor 2GHz or faster (x86)

■ Memory

2GB or more

CAUTION

Although this product has been checked for use with typical computers that meet the above operating requirements, we cannot guarantee that it will operate with all computers that meet these requirements. Please be aware that even in the same conditions, computer processing capabilities can vary depending on differences in design and specifications.

Mac OS X

■ Supported operating systems

OS X El Capitan (10.11 or later)

OS X Yosemite (10.10 or later)

OS X Mavericks (10.9 or later)

OS X Mountain Lion (10.8 or later)

OS X Lion (10.7 or later)

OS X Snow Leopard (10.6.8 or later)

■ Supported computer systems

Mac with a USB 2.0 port

■ CPU/clock speed

Dual core processor 2GHz or faster (x86)

■ Memory

2GB or more

Installing the driver

A driver must be installed on the computer to use this unit.

Download the latest driver for the operating system you are using from the TEAC Global Site (<http://teac-global.com/>).

CAUTION

- *Since digital audio signal processing puts a fairly heavy load on the computer, the operation of other applications, particularly graphic-intensive applications and Internet tools, could cause processing to fall behind. Do not run other applications when using audio applications.*
- *Restarting the computer might be necessary after installation or uninstallation completes. Save your data and conduct other necessary steps in other applications before quitting them.*

Installing the driver for Windows

NOTE

- *Install the driver on the computer before connecting the unit to it with the USB cable. If you already connected the USB cable, and the Found New Hardware Wizard launched, cancel and quit the wizard and disconnect the USB cable.*
- *When installing the driver, a warning might appear with a message such as, "The software you are installing for the hardware has not passed Windows Logo testing to verify its compatibility with Windows." If this message appears, click "Continue Anyway" to proceed with the installation.*

■ Driver installation procedures

1. Download the latest driver for the operating system you are using from the TEAC Global Site (<http://teac-global.com/>) and save it on the computer to be used with the unit.
2. Open the saved driver (zip file) on, for example, the computer desktop.
3. Double-click the "setup.cmd" file in the folder that was created when you opened the zip file.

CAUTION

If you open a zip file without decompressing it and double-click the "setup.cmd" file in the folder that opens, installation will not start. Right-click the zip file and, for example, select "Extract All..." to decompress it and then try again.

4. When the language selection screen (below) appears, select the language you prefer and then click the "OK" button.

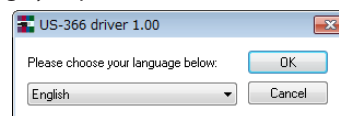

3 – Installation

- Click the “Install the Driver” button when the screen below appears.

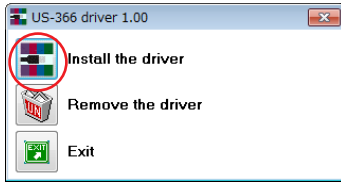

- Read the contents of the License Agreement, and select “I accept the agreement” if you agree to the terms. Next, click the “Install” button to start installation.

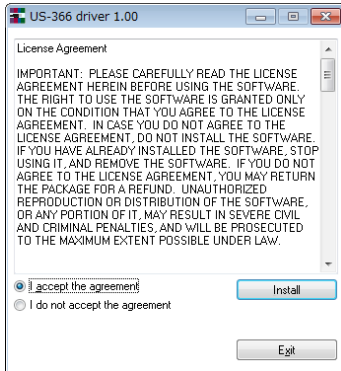

- When the screen below appears, use the supplied USB cable to connect the unit to the PC.

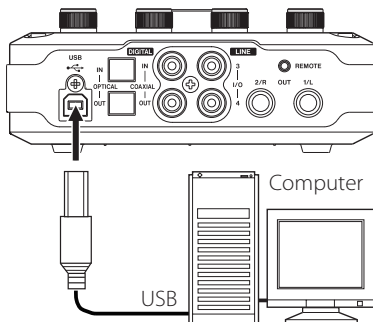
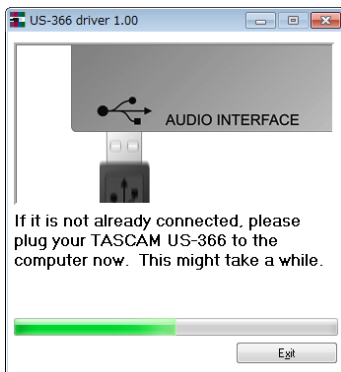

- When the screen below appears, the installation is complete. Click the “Reboot now” button to restart the PC to use the driver.

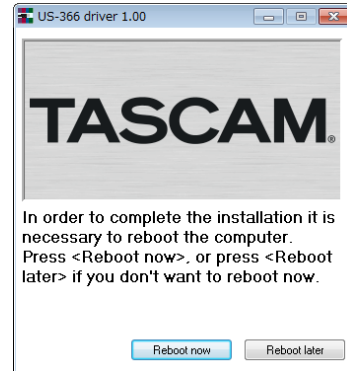

Installing the driver for Mac OS X

NOTE

- Install the driver on the computer before connecting the unit to it with the USB cable. If the USB cable is connected, cancel driver installation and disconnect it before starting driver installation again.
- During driver installation a warning message such as “TASCAM_US-322_US-366_X.XX” can't be opened because it was not downloaded from the Mac App Store.” might appear. If a message like this appears, follow the instructions in “Working with Gatekeeper” on page 13 and then proceed with the installation.

Driver installation procedures

- Download the latest driver for the operating system you are using from the TEAC Global Site (<http://teac-global.com/>) and save it on the computer to be used with the unit.
- Double-click TASCAM_US-322_US-366_Driver_X.XX.dmg, which is the downloaded and saved disk image file, and double-click “TASCAM US-322 US-366 X.XX” inside the folder that opens. Do not connect the unit to the computer before the drivers are installed.

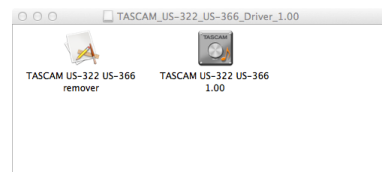

NOTE

Depending on the computer's settings, the downloaded dmg file might not have opened automatically. In this case, open the dmg file first and then double-click the disk image file.

- After the installer launches, follow the instructions on the screen to proceed with the installation.

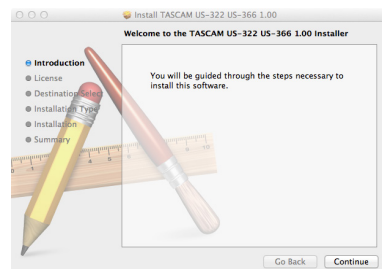

- Click the “Restart” button to quit the installer and restart the computer.

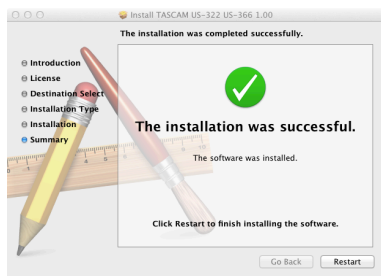

■ Working with Gatekeeper

Depending on the Gatekeeper setting, a warning message might appear during installation.

The solution depends on the warning message shown.

See the following explanations for details.

- When the Gatekeeper setting is “Allow applications downloaded from: the Mac App Store”

“TASCAM_US-322_US-366_X.XX” can’t be opened because it was not downloaded from the Mac App Store.” might appear as a security warning message.



In this case, click the OK button to close the message. Then, control-click (or right-click) the file and click “Open”.

When the “TASCAM_US-322_US-366_X.XX” is not from the Mac App Store. Are you sure you want to open it?” security warning message appears, click the “Open” button.

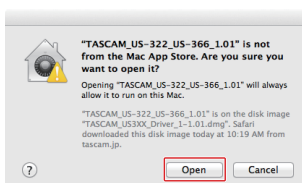

This warning message might also appear when the Gatekeeper setting is something other than “Allow applications downloaded from: the Mac App Store”.

The file still might not open and “TASCAM_US-322_US-366_X.XX” can’t be opened because it was not downloaded from the Mac App Store.” might appear again.

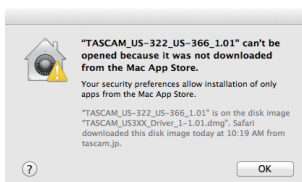

In this case, copy the file from the folder where it is to the desktop or another folder, and then open it. Alternatively, change the Gatekeeper settings to “Allow applications downloaded from: the Mac App Store and identified developers” and try opening it again.

- When the Gatekeeper setting is not “Allow applications downloaded from: the Mac App Store”

“TASCAM_US-322_US-366_X.XX” is an application downloaded from the Internet. Are you sure you want to open it?” might appear as a security warning message. In this case, click the “Open” button.

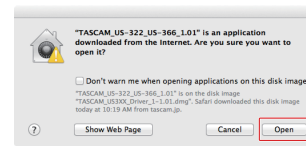

- Changing the Gatekeeper setting

The Gatekeeper setting can be changed using the “Allow applications downloaded from:” item on the “General” page of the “Security & Privacy” pane of the System Preferences.

To change this, you must click the lock icon (🔒) at the bottom left and enter a password to unlock the settings.

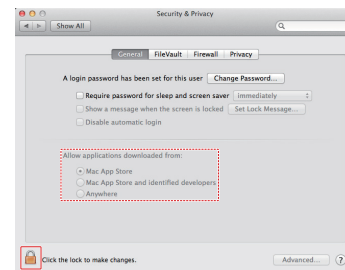

This setting will lock again when you click the “Show All” button at the top left of the window to close the open pane or when you quit the System Preferences by, for example, clicking the quit button at the top left corner of the window (⏻) or typing command-Q.

CAUTION

Changing the Gatekeeper settings could result in security risks.

If you changed the Gatekeeper setting to decrease security (use one of the lower settings), set it back to the original setting after updating the driver and/or firmware.

Uninstalling the driver

■ Windows

There are two ways to uninstall the driver.

Uninstalling from the “setup.cmd” file used during installation

- Follow the procedures in steps 2 to 4 of “Installing the driver for Windows” on page 11.
- In step 5, click the “Remove the driver” button.

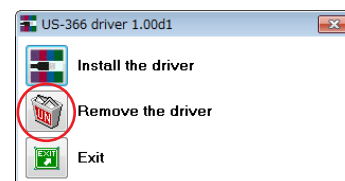

- The following screen appears when uninstallation has completed.

Click the “Reboot now” button. The uninstaller will quit and the computer will restart.

3 – Installation

Uninstalling from the Windows “Programs and Features” Control Panel

1. From the Start menu, open the Control Panel application, click Programs and then click Programs and Features.

NOTE

Follow these procedures to open the Control Panel.

Windows 10 / Windows 8.1

Right-click the Windows Start button and select Control Panel.

Windows 7

Left-click the Windows Start button and select Control Panel from the Start menu.

2. If “View by:” is set to “Category”, click “Uninstall a program” under the “Program” item.
If “View by:” is set to “Large icons” or “Small icons”, click “Programs and Features”.
3. Double-click “US-366 driver” in the list.
4. Then, follow the instructions that appear on the screen.

■ Mac OS X

1. Double-click the “TASCAM_US-322_US-366_Driver_X.XX.dmg” disk image file that was used during installation, and double-click “TASCAM US-322 US-366 remover” inside the folder.



TASCAM US-322 US-366
remover

2. Follow the instructions on the screen for the remaining procedure.

Frequently asked installation questions and answers (FAQ)

Windows driver installation

- Q: When I connect the unit to a computer, the Windows Hardware Wizard appears and I cannot install the driver. Am I making a mistake during the installation procedures?
- A: Close the Windows “Hardware Wizard” and disconnect the unit. You must install the driver before connecting this unit. Download the driver from the TEAC Global Site (<http://teac-global.com/>), and uncompress the zip archive. Then, execute “setup.cmd” and follow the instructions on screen.

Improving computer performance

In this manual, we will offer only the following basic tip to improve performance when using this unit.

- Do not run other applications.

Processing digital audio places a considerable load on your computer. You probably use the computer for applications other than audio, but we recommend that you avoid running them when using audio programs. This means that if you are running other applications (especially ones that are graphics-intensive or that use Internet tools) at the same time as an audio application, processing may not be able to keep up the audio data.

Connections

Precautions before making connections

- Carefully read the operation manuals of the devices to be connected and then connect them correctly.
- Before making connections, turn this unit and all equipment to be connected off (standby).
- Install all connected devices, including this unit, so that they are powered from the same line. When using a power strip or similar device, be sure to use one that has high current capacity (thick cable) in order to minimize fluctuations in power voltage.

Example of using US-366 connections

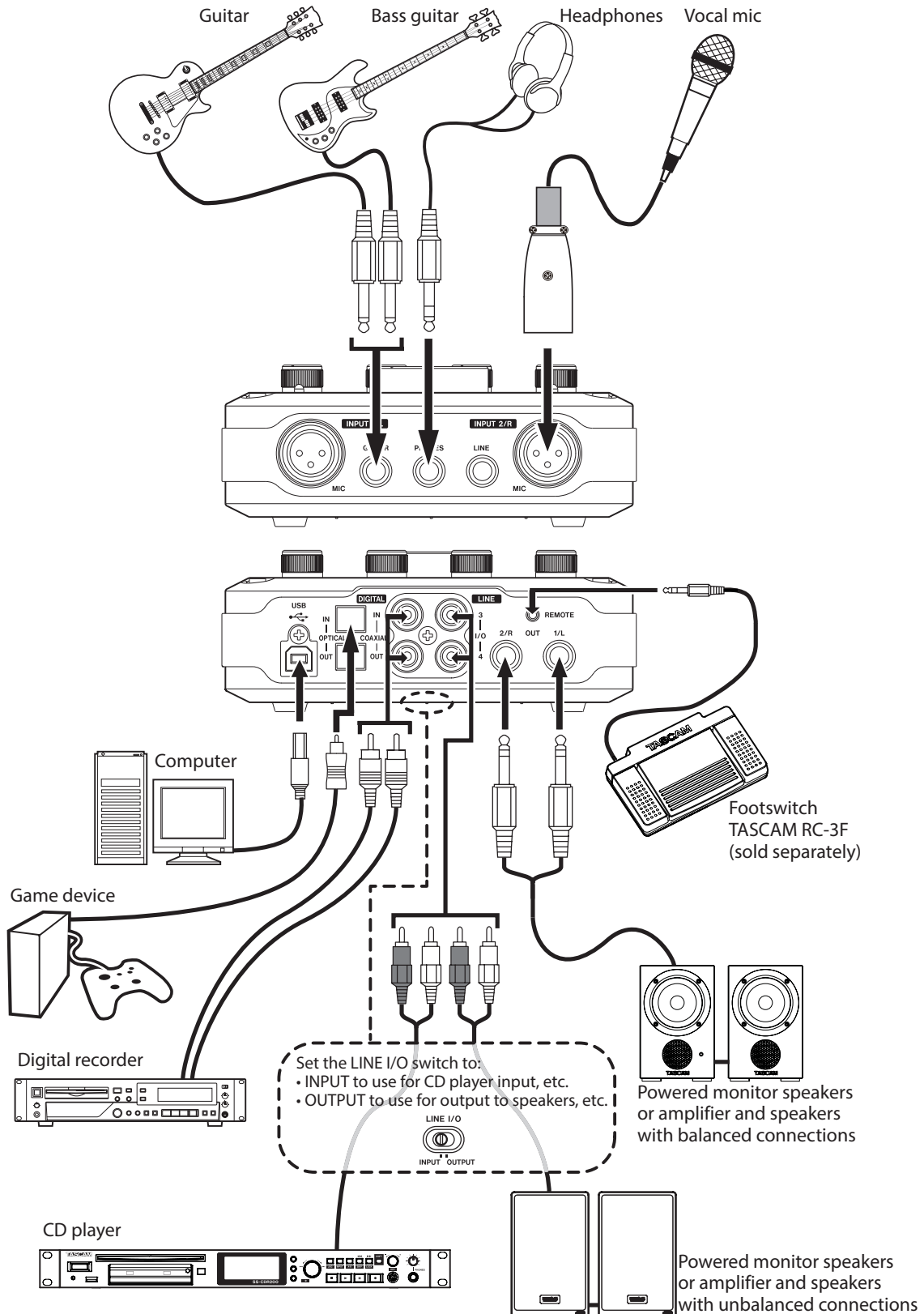

4 – Connections

USB connections

Use the included USB cable to connect the US-366 to your computer as shown in the illustration. When the USB connection is active, the **USB** indicator on the top of the unit lights.

CAUTION

Some USB devices access the USB bus frequently. To avoid dropouts and clicks in the audio signal, we strongly recommend that you do not connect any USB devices other than keyboards and mice to the USB bus used by this unit.

Audio connections

Analog audio signals input into this device from mics, guitars, keyboards and other audio equipment can be converted into digital signals and transmitted to the computer via USB. Connect the output of the US-366 to your speakers (via an amp) or headphones, so you will be able to monitor the audio signals coming into the US-366 or being produced by your computer.

CAUTION

*Before connecting an audio device, set the **INPUT 1/2**, **PHONES** and **LINE OUT** knobs to their minimum values. Failure to do so could cause sudden loud noises from monitoring equipment, and this could damage the equipment or harm hearing.*

Microphones

Connect microphones to the **INPUT 1/L** and **INPUT 2/R MIC** connectors (XLR) on the front panel.

When using a condenser microphone that requires phantom power, set the **48V** switch on the front panel to **ON**.

When the **48V** switch is set to **ON**, the **48V** indicator on the top panel lights.

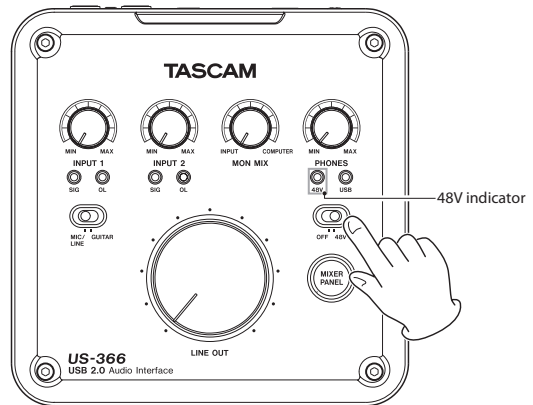

CAUTION

- Set the **LINE OUT** and **PHONES** knobs to their minimum values before changing a **48V** switch setting. Failure to do so could cause sudden loud noises from monitoring equipment, and this could damage equipment or harm hearing.
- Do not connect or disconnect mics when the **48V** switch is set to **48V**. Doing so could cause a loud noise and might damage this unit and connected equipment.
- Set the **48V** switch to **48V** only when using a condenser microphone that requires phantom power.
- When using condenser mics that require phantom power and dynamic mics together, be sure to use balanced dynamic mics. Unbalanced dynamic mics cannot be used when phantom power is enabled.
- Always set the **48V** switch to **OFF** before turning the unit's power on or off.
- Do not use phantom power when line level equipment is connected to an XLR connector. It might damage equipment.
- Supplying phantom power to some ribbon mics will break them. If you are unsure, do not supply phantom power to a ribbon mic.

Guitars

Connect a guitar or bass guitar to the **INPUT 1/L LINE/GUITAR** jack on the front of the unit and set the **MIC/LINE-GUITAR** switch on the top to **GUITAR**.

Sound module/MD/CD etc. (digital connection)

Connect the digital inputs and outputs of these types of devices to the unit's **DIGITAL IN** and **OUT** jacks on the rear panel.

Connect a coaxial cable for input to the **COAXIAL IN** jack and one for output to the **COAXIAL OUT** jack.

Connect an optical cable for input to the **OPTICAL IN** connector and one for output to the **OPTICAL OUT** connector.

The output signal can be output from both connectors at the same time, but both digital inputs cannot be used at the same time. Set the **DIGITAL IN** switch on the bottom of the unit to select which input to use.

NOTE

This unit can output either S/PDIF or AES/EBU digital signals. Set the type of output using the control panel.

Set the type of output on the "INTERFACE" page of the "Mixer Panel".

CAUTION

When using a digital input, you must set "Sample Clock Source" to "automatic" on the "INTERFACE" page of the "Mixer Panel". This makes the connected device into the clock master.

*If "Sample Clock Source" is set to "internal" no signal will be input through the **DIGITAL IN** jack, and the **DIGITAL OUT** signal will be looped back inside the US-366 to the digital input. In this case, depending on the settings of the computer software that you are using, the digital out signal could become looped, causing noise. We describe an example of this situation and measures to prevent it below*

Example:

*In the DAW application, suppose that the input of a track is assigned to the US-366 **DIGITAL IN** and its output is assigned to the US-366 **DIGITAL OUT**. In this case, the following noise loop is created if the input of that track is monitored: track output to US-366 digital output to US-366 digital input to track input to track output, and so on.*

Countermeasure:

To prevent this type of loop, turn input monitoring off in the DAW software or assign the input of that track to anything besides the US-366 digital input.

Connecting keyboards, drum machines, sound modules, cassette/MD/CD players and other analog line level devices

Connect the analog signal outputs of these types of devices to the **INPUT 1/L LINE/GUITAR** and **INPUT 2/LINE** jacks on the front of the unit.

You can also set the **LINE I/O** switch on the bottom of the unit to **INPUT** to enable input connection to the **LINE I/O 3** and **4** RCA pin jacks.

Analog record player

The output of an analog record player cannot be connected directly to the US-366. You must connect a phono amp between your analog record player and the US-366. (Alternatively, you can connect it via the rec or line outs of an audio amp that has PHONO inputs.)

Monitor speakers

You can connect monitor speakers (powered speakers or an amplifier and speakers) with a balanced connection to the **LINE OUT 1/L** and **2/R** TRS jacks on the rear panel.

You can also connect monitor speakers with an unbalanced connection to the **LINE I/O 3** and **4** RCA pin jacks on the rear panel when the **LINE I/O** switch on the bottom is set to **OUTPUT**.

Headphones

Connect headphones to the standard stereo **PHONES** jack on the front panel.

Foot switch

You can connect a TASCAM RC-3F foot switch (sold separately) to the **REMOTE** jack (2.5mm mini).

5 – Using the Mixer Panel

Press the **MIXER PANEL** button on the top of the unit to open the Mixer Panel on the display of the connected computer.

The mixer panel has three pages.

Click on a tab to open the corresponding page.

INTERFACE: View information about the driver status and connection and make various settings.

MIXER: Make built-in mixer settings.

EFFECTS: Make built-in effects settings.

Mixer panel settings

“INTERFACE” page

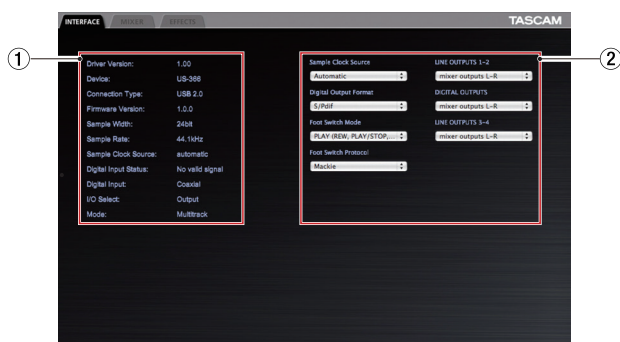

The “INTERFACE” page appears divided into the following two sections.

① Status display section

This shows information about the current driver and the connected hardware. The current settings of the switches on the bottom of the unit are also shown.

NOTE

- If the “Digital Input Status” is “Valid Signal”, a valid digital signal is being input. If it is “No Valid Signal”, no valid digital signal is being detected. Check the setting of the switch on the bottom of the unit and confirm that the digital output of the connected equipment meets the requirements for input into this unit.
- Settings cannot be made in this section.

② Setting section

This has various driver settings that can be changed.

Audio Performance

This unit’s driver temporarily stores the audio signals input to and output from the computer in a buffer.

The size of this buffer can be adjusted.

The smaller the size of the buffer, the shorter the audio signal delay (latency). However, the smaller the size, the greater the demand on the computer processor. If the audio data cannot be processed in time due to the demands of other system operations, for example, clicking and popping noises as well as audio dropouts and other audio problems might occur.

The larger the buffer size, the more stable the operation, making the processing of audio signals less likely to be hindered by other system operations. However, larger buffer sizes also increase the latency of the audio handled by the computer.

You can set the buffer size used for this unit according to your conditions.

When using Windows, adjust the buffer size using its “Audio Performance” Control Panel. The “lowest latency” setting is

the smallest buffer size, while the “highest latency” setting is the largest.

When using Mac OS X, you can adjust the buffer size for each audio application that you are using. For this reason, there is no “Audio Performance” control panel in Mac OS X. For details, see the operation manual for the audio application that you are using.

Sample Clock Source

You can set the clock source to “Automatic” or “Internal”. Set it to “Automatic” if you are using a digital input.

When set to “Automatic”, the “Sample Clock Source” will automatically switch to “Digital” when there is a digital input and switch to “Internal” (internal clock) when there is no digital input.

- Automatic (default): If a clock signal is input through the **DIGITAL IN** jack, it is used. If no signal is input through the **DIGITAL IN** jack, this unit’s internal clock is used.
- Internal: This unit’s internal clock is always used.

Digital Output Format

Set the digital output format to “S/PDIF” or “AES/EBU”.

LINE OUTPUTS and DIGITAL OUTPUTS (output selection)

This model outputs up to six signal channels. The options available depend on the settings of the **LINE I/O** and **MODE** switches on the bottom of the unit. Refer to the following table for a summary of the available options.

Setting item	Output (connector)	MODE***	
		MULTITRACK	STEREO MIX
LINE OUTPUTS 1-2	LINE OUT 1/L, 2/R	mixer outputs L-R	mixer outputs L-R
		computer 1-2	
		computer 3-4	
		computer 5-6**	
DIGITAL OUTPUTS	DIGITAL OUT	mixer outputs L-R	mixer outputs L-R
		computer 1-2	
		computer 3-4	
		computer 5-6**	
LINE OUTPUTS 3-4*	LINE OUT 3, 4	mixer outputs L-R	mixer outputs L-R
		computer 1-2	
		computer 3-4	
		computer 5-6**	

*Usable only when the **LINE I/O** switch on the bottom of the unit is set to **OUTPUT**.

Selectable only when the **LINE I/O switch on the bottom of the unit is set to **OUTPUT**.

***Set using the **MODE** switch on the bottom of the unit.

NOTE

If you want to output Windows Media Player or iTunes, for example, through this unit’s **DIGITAL OUT**, set the “DIGITAL OUTPUTS” to “computer 1-2” in the Control Panel.

CAUTION

- With the US-366 model, if the sampling frequency is set to 176.4 kHz or 192 kHz, the signal selected using the “DIGITAL OUTPUTS” item will be output regardless of the “LINE OUTPUTS 3-4” setting.
- If “mixer output L-R” is not selected for any of the items “LINE OUTPUTS 1-2”, “DIGITAL OUTPUTS” and “LINE OUTPUTS 3-4”, the mixer functions will not operate.

5 – Using the Mixer Panel

Foot Switch Mode

When using a US-366 with a DAW application, you can connect a TASCAM RC-3F foot switch remote control (sold separately) to control the DAW.

You can select from two types of functions for the pedals (switches).

- **PLAY (REW, PLAY/STOP, FWD) (default setting)**

These assigned functions are particularly useful for playback operations. The PLAY/STOP function assigned to the center pedal allows you to press it briefly to PLAY and press and hold it to STOP.

- **RECORD (PLAY, REC, STOP)**

The assigned functions are useful particularly for recording operations.

	FOOT SW		
	L (brief)	C (brief)	R (brief)
PLAY	REW	PLAY	FWD
	-----	STOP	-----
RECORD	PLAY	REC	STOP
	-----	-----	-----

Foot Switch Protocol

You should set the protocol to match the DAW application you are using. If the foot switch remote control does not function, change the setting.

Mackie: Mackie control protocol

HUI: HUI protocol

For information about these protocols and how to use them with a DAW application, refer to that application's operation manual.

“MIXER” page

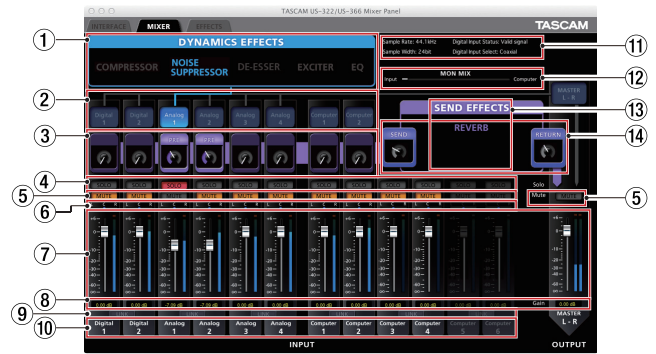

Click the MIXER tab to open the page shown above. On this page, you can adjust the built-in mixer settings.

① DYNAMICS EFFECTS type selection

Select the type of dynamics effect to use.

You can select and use one type of effect at a time. (Simultaneous selection of two or more effects is not possible.)

ON: Effect name blue

OFF (default): Effect name gray

Click the name of the effect that you want to use to turn it on. When on, the effect name appears blue.

Click the name of the effect that is on (name blue) to turn it off. When off, the effect name appears gray.

To use a different effect, click the name of that effect to turn it on. The previously used effect is automatically turned off.

This setting is retained even when the unit is turned off and on again.

NOTE

Depending on the sampling frequency setting, it might not be possible to turn an effect on.

② Dynamics effect assignment

Select the channel that you want to use the dynamics effect on.

You can select one mono or one stereo channel. (Simultaneous selection of multiple channels is not possible.)

ON: Channel name blue

OFF (default): Channel name gray

Click the name of a channel to assign the dynamics effect to it. When assigned, the channel name becomes blue.

At the same time, the line between the dynamics effects area and the channel turns blue.

To stop applying the dynamics effect to the assigned channel, click that channel's button. The line between the dynamics effect area and the channel turns gray.

To reassign the dynamics effect to a different channel, click the button of that channel. The dynamics effect will automatically be removed from the previous channel (line turns gray) and assigned to the new channel (line turns blue).

This setting is retained even when the unit is turned off and on again.

5 – Using the Mixer Panel

③ Effects send bus signal setting

There are three options. The signal can be sent to the send bus either before (PRE) or after (POST) the fader, or not sent at all (OFF).

PRE: Signal sent before fader

POST (default): Signal sent after fader

OFF: Signal not sent (nothing appears)

This setting is retained even when the unit is turned off and on again.

Click the top of the frame to cycle through the options in the following order.

OFF → PRE → POST → OFF

Use the knob inside the frame to adjust the send level.

Level: 0 (–inf) – 127 (0dB) (default: 0 (–inf))

Click and hold the knob that you want to adjust and drag up and down to adjust the level. The current value appears beneath the knob while the mouse button is being held down.

Level settings are retained even when the unit is turned off and on again.

④ SOLO buttons

Use these buttons when you want to listen to or mix only audio from selected channels.

You can solo multiple channels at the same time.

When one or more channels is soloed, all other channels are automatically muted.

This is convenient when you only want to listen to or mix a few channels because it is easier than using multiple “MUTE” buttons.

ON: Button appears red

OFF (default): Button appears gray

Click a SOLO button to turn the function on/off for that channel.

When all the “SOLO” buttons are off, clicking the “SOLO” button for one channel activates solo mode, automatically muting all the other channels.

When all the “SOLO” buttons are turned off again, solo mode is deactivated. At this time all channels that had been automatically muted are unmuted again, and mute settings are restored to their state before solo mode was activated.

NOTE

- *Solo mode does not automatically activate the master channel “MUTE” button.*
- *Solo settings are not retained when the unit is turned off and on again (solo buttons are turned off).*

⑤ MUTE buttons

Use these to turn the mute function on/off for each channel.

ON: Button appears orange (channel muted)

OFF (default): Button appears gray

Click a “MUTE” button to turn the function on/off for that channel.

This setting is retained even when the unit is turned off and on again.

NOTE

In addition to being turned on and off when they are clicked, “MUTE” buttons are also automatically turned on and off when “SOLO” buttons are used. See “④ SOLO buttons” above for details.

⑥ Pan sliders

These adjust the stereo position (left – center – right) of the channel signal sent to the master bus.

When set all the way left (L15), the signal from that channel is sent only to the master bus left channel. No signal is sent to the right bus.

When set all the way right (R15), the signal from that channel is sent only to the master bus right channel. No signal is sent to the left bus.

When set to the center (C), the channel signal level is lowered –3dB and sent to both the left and right channels of the master bus.

Including the central position and 15 steps to both left and right, there are 31 steps total.

The slider appears blue when set to the center (C) and yellow at all other positions.

Click and drag the pan slider left or right to change the stereo position.

While you are clicking the pan slider, the pan position appears in the area where the fader levels are shown (⑧ in the illustration on page 19).

You can reset the pan slider to the center (C) position by control-clicking it when using a Windows PC or command-clicking it when using a Mac.

When two channels are linked (“LINK” button is on), the pan slider adjusts the volume balance between the left (odd) and right (even) channels.

This setting is retained even when the unit is turned off and on again.

⑦ Faders

These adjust the levels of each channel in the mix.

Range: +6dB to –inf in 147 steps, default: 0dB

Click and drag a fader up or down to adjust its level.

Drag it up to increase its level (–inf → 6dB), or drag it down to decrease its level (6dB → –inf).

The fader level gain value is shown in the fader level area (⑧ in the illustration on page 19).

You can reset the fader to 0dB by control-clicking it when using a Windows PC or command-clicking it when using a Mac.

⑧ Fader level and pan position display area

This shows the level of the fader above as a digital value.

This shows the pan position when the pan slider above is being moved using the pointer.

5 – Using the Mixer Panel

⑨ Link buttons

These buttons allow you to link adjacent odd (left) and even (right) channels, such as channels 1 and 2 or 3 and 4, into stereo pairs in the mixer.

The mixer functions of two linked channels are combined into a single channel strip.

ON: Button appears yellow

OFF (default): Button appears gray

Click a "LINK" button when the link is off to turn it on and unite the two channel strips into one stereo channel strip. The following mixer settings are applied to this stereo channel.

Dynamics effect: Setting of odd (left) channel

Send effect: Setting of odd (left) channel

Solo: Setting of odd (left) channel

Mute: Setting of odd (left) channel

Pan slider: Center (C) (now used to adjust balance)

Fader: Setting of odd (left) channel

The two linked channel strips function as a single channel strip.

Press the "LINK" button when the link is on to turn it off and split the stereo channel strip into two mono channel strips. The following mixer settings are applied to those channels.

Dynamics effect: If the effect had been on previously, it will continue to be on for the odd (left) channel, but it will be off for the even (right) channel. If the effect had been off previously, it will continue to be off for both channels.

Send effect: Both channels retain the previous setting.

Solo: Both channels retain the previous setting.

Mute: Both channels retain the previous setting.

Pan sliders: Center (C) (now used to adjust pan)

Faders: Both channels retain the previous setting.

This setting is retained even when the unit is turned off and on again.

⑩ Channel names

These are the channel names of the unit's input connectors and the computer's outputs.

Channels that can be used appear lit, while channels that cannot be used appear dimmed.

The channels that can be used change according to the According to **MODE** and **LINE I/O** switch settings

This setting is retained even when the unit is turned off and on again.

⑪ Status display section

The main items related to the driver status and connected hardware shown in the Status display section of the "INTERFACE" page are shown here.

"Sample Rate": Sampling frequency

"Sample Width": Quantization bits

"Digital Input Status": status of digital input

Message	Meaning
"Valid signal"	Valid digital signal being detected
"No valid signal"	Valid digital signal not detected

"Digital Input Select": Shows the digital input currently selected by the **DIGITAL IN** switch on the bottom of the unit.

⑫ Monitor mix setting

This shows the setting of the monitor mix volume knob on the top of the unit.

This only shows the value. You cannot change it here.

The closer it is to "Input", the higher the volume of the signals input through the unit will be. The closer it is to "Computer", the higher the volume of the computer playback signals will be.

⑬ SEND EFFECTS

Set to use the send effects (REVERB).

ON (REVERB) (default): Name appears purple

OFF: Name appears gray

Click the effect name (REVERB) inside the "SEND EFFECTS" frame to turn it on. When on, the name turns purple.

Click the name of the effect (REVERB) when it is on (appears purple) to turn it off (turns gray).

This setting is retained even when the unit is turned off and on again.

NOTE

You cannot turn a send effect on when it is disabled due to the sampling frequency setting.

⑭ SEND master and RETURN level knobs

Use these to adjust to send and return levels (default: 0 (-inf) for both).

SEND: Use to adjust the level input to the effect send bus.

RETURN: Use to adjust the send effect output level. Click and drag a knob up or down to adjust the level.

Drag it up to increase its level (0 → 127), or drag it down to decrease its level (127 → 0).

When you are clicking a knob, its setting appears beneath it.

This setting is retained even when the unit is turned off and on again.

NOTE

This SEND knob adjusts the overall level of all channels sent to the effect. To adjust the send level of a specific channel, use the knob in 3 above.

5 – Using the Mixer Panel

“EFFECTS” page



Click the “EFFECTS” tab to open the effects page where you can adjust the built-in effect settings.

Limitations on the use of the built-in effects

The number of built-in effects that can be used depends on the sampling frequency.

- At 44.1/48kHz, one dynamics and one send effect can each be used.
- At 88.2/96kHz, either one dynamics effect or one send effect can be used. (Turning on an effect will automatically turn off the other effect if it has been on.)
- At 176.4/192kHz, the built-in effects cannot be used.

① Dynamics effect tabs

Use to select the dynamics effect that is shown. Click a tab to bring that effect to the front. The dynamics effects are “COMPRESSOR” (default), “NOISE SUPPRESSOR”, “DE-ESSER”, “EXCITER” and “EQ”.

This setting is retained even when the unit is turned off and on again.

② Parameter knobs

Use these to adjust the effect parameters.

Click and drag a knob up or down to adjust its setting value. Drag up to increase the value and turn the knob clockwise. Drag down to decrease the value and turn the knob counter-clockwise.

The current value of each parameter is shown above its knob.

For details about each parameter, see “Effect explanations” on page 23.

These settings are retained even when the unit is turned off and on again.

③ Dynamics effect ON/OFF button and indicator

Use this button to turn a dynamics effect on and off.

ON: The button turns red and “ON” appears next to it. The name of the effect appears brighter.

OFF (default): The button dims and “OFF” appears next to it. The name of the effect appears dimmed.

When a dynamics effect is off, click its ON/OFF button or name to turn it on. When on, click the button or name to turn it off.

Moreover since only one dynamics effect can be used at a time, when an effect is on, turning on another effect will automatically turn that effect off.

This setting is retained even when the unit is turned off and on again.

NOTE

- The dynamics effect ON/OFF setting on this page is linked to its setting on the mixer panel, so turning it on or off here will also change its setting there.
- Depending on the sampling frequency setting, it might not be possible to turn an effect on.

④ Effect type selection switch

You can select the type of reverb used for the send effect.

Click the name of the type that you want to use to change the selection. The switch will point to the new selection, and the name of the selected type will appear green. The other types will appear white. (The default setting is HALL.)

For details about each parameter, see “Effect explanations” on page 23.

This setting is retained even when the unit is turned off and on again.

⑤ Send effect ON/OFF button and indicator

Use this button to turn the send effect on and off.

ON: The button turns red and “ON” appears next to it.

OFF (default): The button dims and “OFF” appears next to it.

When a send effect is off, click its ON/OFF button or name to turn it on. When on, click the button or name to turn it off.

This setting is retained even when the unit is turned off and on again.

NOTE

- The send effect ON/OFF setting on this page is linked to its setting on the mixer panel, so turning it on or off here will also change its setting there.
- Depending on the sampling frequency setting, it might not be possible to turn an effect on.

■ Effect explanations

Dynamics effects

● Compressor

When the input volume exceeds the “THRESHOLD” level set in advance, the input volume will be compressed, reducing output volume variation.

For example, by reducing the high level parts when sound occurs, the lower level sounds become relatively louder, creating a more even volume. You can also use this as a limiter to prevent signal levels from becoming too high.



The three meters show the level of the signal input to the compressor (“INPUT”), the level of the signal output from the compressor (“OUTPUT”) and the gain reduction caused by the compressor (“GR”).

THRESHOLD: -32 to 0 dB (default: -12dB)

Sets the threshold level that will cause the input signal volume to be compressed when it is exceeded.

RATIO: 1.0:1 to inf:1 (default: 1.5:1)

Sets the compression ratio for the volume. Turning it right raises the compression ratio, increasing the amount of compression.

ATTACK: 2 to 200 ms (default: 20 ms)

Sets the amount of time until the compression reaches the compression RATIO setting after the input sound exceeds the threshold.

RELEASE: 10 to 1000 ms (default: 420 ms)

Sets the amount of time until the compression stops and the sound returns to its uncompressed level after the input sound goes below the threshold.

GAIN: 0 to 32 dB (default: 4 dB)

Sets the gain of the output signal. When the volume is compressed, the output level becomes lower than the input level.

Use the “GAIN” to amplify the output level so that it is close to the input level.

If the input is a stereo signal, compression will start and be applied to both channels when either the left or right input channel exceeds the threshold level.

NOTE

When the compressor is off, the compressor curve will appear but the meters will not be active.

● Noise suppressor

When the input volume becomes less than the threshold level set in advance, the output level will be reduced automatically to suppress noise. When the threshold level is exceeded, the sound will be output at its ordinary level. This effect is useful in applications to reduce noise during pauses in performance or other sound input.



THRESHOLD: -84 to -24 dB (default: -64 dB)

Sets the threshold level that will cause noise suppression if the input signal becomes less than it.

SUPPRESSION: 12 to 72 dB (default: 42 dB)

Sets the amount the output level will be reduced when the input sound becomes less than the threshold level. The higher the value, the more the output level and noise will be reduced.

ATTACK: 0 to 4000 ms (default: 5 ms)

Sets the amount of time until the set suppression level is reached after the input sound goes below the threshold.

RELEASE: 0 to 4000 ms (default: 320 ms)

Sets the amount of time until suppression stops after the input sound exceeds the threshold.

When the input is a stereo signal, if both the left and right input channels go below the threshold level, noise suppression will start.

● De-esser

This is a compressor specialized for high frequencies that reduces “s” sounds and other harsh high-frequency noises.



FREQUENCY: 1 to 4 kHz (default: 1.15 kHz)

Sets the lowest frequency that the de-esser effects.

DEPTH: 1 to 100 (default: 25)

Sets the amount of compression. The higher the value the greater the compression (and de-essing effect).

5 – Using the Mixer Panel

● Exciter

This effect emphasizes high-frequency harmonics to add clarity and sparkle while maintaining the original sound.



FREQUENCY: 1 to 4 kHz (default: 2.00 kHz)
Sets the frequency above which harmonics are emphasized.

DEPTH: 1 to 100 (default: 75)
Sets the amount that harmonics are emphasized. The higher the value, the more they are emphasized.

● Three-band parametric equalizer

This can be used to increase or decrease the levels of specific frequency ranges. This can be used to enhance the sound of individual instruments, to adjust the balance of a wide frequency range and to cut specific unwanted frequencies, for example.



The frequency response is shown even when the equalizer is off. The equalizer has a high-shelf HIGH band, a low-shelf LOW band and a peaking (bell-shaped) MID band.

HIGH GAIN: –12 to 12 dB (default: 0 dB)
Sets the amount the level is increased or decreased for the high shelf.

HIGH FREQ: 1.7 to 18 kHz (default: 10 kHz)
Sets the cutoff frequency of the high self.

Mid GAIN: –12 to 12 dB (default: 0 dB)
Sets the amount the level is increased or decreased for the mid peak.

Mid FREQ: 32 Hz to 18 kHz (default: 1.0 kHz)
Sets the center frequency of the peak.

Mid Q: 0.25 to 16 (default: 0.5)
Sets the acuteness of the peak. The higher the value the narrower it becomes, making it effect a narrower frequency band. The lower the value, the wider it becomes, making it effect a broader frequency band.

Low GAIN: –12 to 12 dB (default: 0 dB)
Sets the amount the level is increased or decreased for the low shelf.

Low FREQ: 32 Hz to 1.6 kHz (default: 100 Hz)
Sets the cutoff frequency of the low shelf.

Send effect

● Reverb

This effect adds reverberations to the original sound by adding multiple sounds delayed at various times with damping over time that produces a sound that is as natural as possible. Reverberations like those of a hall, live-music club or a studio, for example, can be generated.



ROOM TYPE: HALL, ROOM, LIVE, STUDIO, PLATE
Select the type of reverb.

Depending on the setting, the density and level of the reverb sound changes.

PRE DELAY: 0 to 250 ms (default: 90 ms)
Set the amount of time until the first reverberations. The larger the value, the larger the reverberations make the room sound.

REVERB TIME: 0.1 to 10 sec (default: 2.7 sec)
Set the amount of time that the reverberations continue. The larger the value, the longer they continue.

5 – Using the Mixer Panel

Resetting settings to their default values

If you want to reset all the current settings to their original values, You can restore the mixer and effect settings to their factory defaults.

Resetting the mixer

Follow these procedures to reset the mixer and output channel settings.

1. Click “File (F)” in the toolbar on a Windows PC or click “TASCAM US-322 US-366 Mixer Panel” in the menu bar on a Mac to open a pulldown menu.

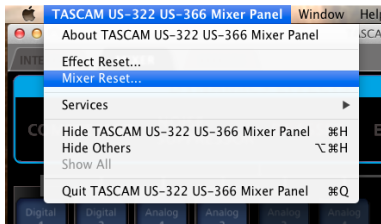

2. Click “Mixer Reset...” in the pulldown menu.
3. When a warning appears as shown below, click “OK”.



CAUTION

After resetting, you cannot restore the previous settings. Before clicking “OK”, confirm that you want to reset the settings.

NOTE

Click “Cancel” to return to the Mixer Panel without resetting.

The mixer and other settings are reset to their default values. The items reset and their default values are as follows.

“MIXER” page items

- Dynamics effect: Off
- Dynamics effect assignment: Off
- Send effect signal position setting (all channels): POST
- Send level (all channels): 0 (–inf)
- Solo (all channels): Off
- Mute (all channels): Off
- Pan slider (all channels): Center
- Fader (all channels): 0 dB
- Link (all channel pairs): Off
- Send effect: REVERB ON
- Send/return levels: 0 (–inf)

“INTERFACE” page items

MULTITRACK mode

- LINE OUTPUTS 1-2: mixer output L-R
- DIGITAL OUTPUTS: computer 1-2
- LINE OUTPUTS 3-4: computer 3-4

STEREO MIX mode

- LINE OUTPUTS 1-2: mixer output L-R
- DIGITAL OUTPUTS: mixer output L-R
- LINE OUTPUTS 3-4: computer 1-2

Resetting the effects

Follow these procedures to reset all the effects, including the one currently shown, to their default values.

1. Click “File (F)” in the toolbar on a Windows PC or click “TASCAM US-322 US-366 Mixer Panel” in the menu bar on a Mac to open a pulldown menu.

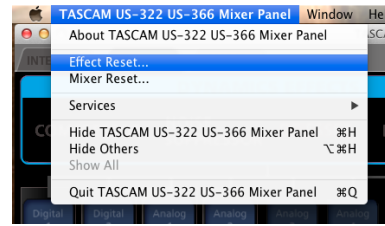

2. Click “Effect Reset...” in the pulldown menu.
3. When a warning appears as shown below, click “OK”.



CAUTION

After resetting, you cannot restore the previous settings. Before clicking “OK”, confirm that you want to reset the settings.

NOTE

Click “Cancel” to return to the Mixer Panel without resetting.

The effect settings are reset to their default values. The items reset are as follows.

COMPRESSOR

THRESHOLD, RATIO, ATTACK, RELEASE, GAIN

NOISE SUPPRESSOR

THRESHOLD, SUPPRESSION, ATTACK, RELEASE

DE-ESSER

FREQUENCY, DEPTH

EXCITER

FREQUENCY, DEPTH

EQ

GAIN and FREQ for all bands (LOW, MID, HIGH) and MID band Q

REVERB

ROOM TYPE, PRE DELAY, REVERB TIME

NOTE

This does not change the effect on/off status or the assignment of the dynamics effect. These items are restored to their defaults by resetting the mixer.

See the “Effect explanations” for the default settings of each effect.

6 – Application Guide

In this chapter, we explain how to set some audio applications for use with this unit.

DAW software

Procedures for making settings differ among DAW software applications. When using a DAW, refer to its operation manual.

Windows Media Player

1. Open the OS Control Panel.

NOTE

Follow these procedures to open the Control Panel.

Windows 10 / Windows 8.1

Right-click the Windows Start button and select Control Panel.

Windows 7

Left-click the Windows Start button and select Control Panel from the Start menu.

2. Double-click Sound in the Control Panel to open it.

NOTE

If the Control Panel display method is set to Icon, a Sound icon will be shown.

3. On the "Playback" page, right-click "Speakers TASCAM US-366" and click "Set as Default Device" in the pop-up menu that appears.

When you do this, the green check mark ("✓") appears next to "Speakers TASCAM US-366".

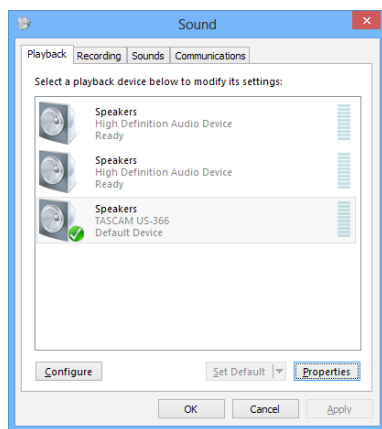

NOTE

If you plan to use this unit for live broadcast over the Internet or otherwise as a recording device, on the "Recording" page, right-click "Line In TASCAM US-366" and click "Set as Default Device" in the pop-up menu that appears.

When you do this, the green check mark appears next to "Line In TASCAM US-366".

5. After completing the setting, click the "OK" button.
6. Start Windows Media Player, and select and play an audio file.

NOTE

- *Windows Media Player will not recognize the device change if you change these settings while it is running. In this case, restart Windows Media Player.*
- *If you still cannot hear sound after making the settings and completing the procedures above, disconnect the USB cable and restart the computer.*

- *After making these settings, sound will be output from this unit, but sound will not be output from the computer speakers or headphone jack.*
- *If you want to output the signal from Windows Media Player through the DIGITAL OUT without passing through the unit's mixer, set "DIGITAL OUTPUTS" to "computer 1-2" on the "INTERFACE" page of the Mixer Panel.*

Mac OS X and iTunes

1. Double-click the Audio MIDI Setup application, which is in the Utilities subfolder of the Applications folder, and then open the Audio Devices window.
2. Click "US-366" to select it, and right-click or control-click "US-366". Then, click "Use this device for sound output" in the pop-up menu.

The speaker mark appears next to "US-366".

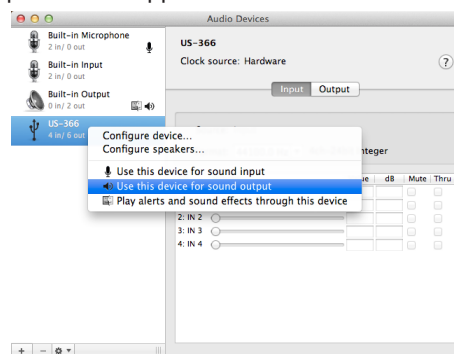

NOTE

If you plan to use this unit for live broadcast over the Internet or otherwise as a recording device, select "Use this device for sound input" for the "US-366". When you do this, the mic icon will move to "US-366".

3. Launch iTunes, select an audio file and start playback.

NOTE

If you want to output the signal from iTunes through the DIGITAL OUT without passing through the unit's mixer, set "DIGITAL OUTPUTS" to "computer 1-2" on the "INTERFACE" page of the Mixer Panel.

Using Audio MIDI setup in OS X Mavericks (10.9) or later

In OS X Mavericks (10.9) or later, two options appear in the Audio Devices list: “US-366 (Bit Accurate)” and “US-366 (Core Audio)”. Only the “Core Audio” setting can be used as the input or output device.

Do not use the “Bit Accurate” option.

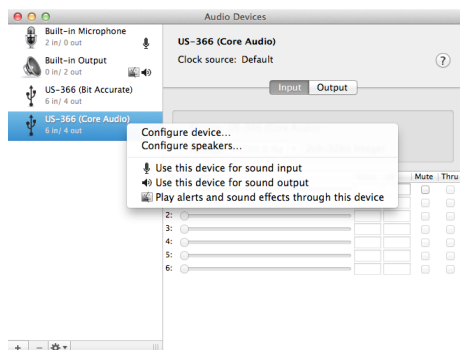

NOTE

- When the “US-366 (Bit Accurate)” option can be selected in a DAW or other software, using it should make recording and playback more stable.
- The “US-366 (Bit Accurate)” option cannot be used with applications downloaded from the Mac App Store. Use the “US-366 (Core Audio)” option with such applications.

7 – Troubleshooting

Please read this chapter if you are unable to use the unit properly even after setting it up following the procedures in this manual.

If you are still unable to resolve your problems please contact TASCAM customer support with the following information about the operating environment and details about the trouble.

Operating environment

- Computer manufacturer
- Model
- CPU
- Installed memory
- OS
- Applications used
- Antivirus software use
- Wireless LAN use

Please see the back of this manual for contact information.

■ Installation fails.

Installation completes, but the computer does not recognize the unit.

If some trouble is causing installation to fail, or installation completes but the computer does not recognize the unit, check the following.

1) USB indicator lit

Is the **USB** indicator on the front panel of the unit lit?

If the **USB** indicator is not lit, confirm that the USB cable is properly connected.

NOTE

Always use the included USB cable.

2) Change the USB port

Since the unit might not function properly with some USB ports, try connecting to a different built-in USB port on the computer, and reinstall the driver (when using Windows).

NOTE

- *Try again after disconnecting other USB devices. (USB keyboards and USB mouse can be left connected.)*
- *Do not use a USB hub. Always connect the unit directly to a built-in USB port on the computer.*

3) Stop other software running in the background

Since antivirus software and other software that runs in the background can interfere with installation, stop other software before beginning installation.

See “3 – Installation” on page 11 of this manual for how to install and uninstall the driver.

■ There is no sound even when audio is playing back.

The audio output must be set on the computer.

Please confirm the following while the unit is connected to the computer.

Note that after making the following settings, sound will be output through the unit, but no sound will be output by the computer's speakers or headphone jacks.

Windows

See the “Windows Media Player” section of “6 – Application Guide” on page 26 of this manual, and set the default playback device as necessary for the OS.

Mac OS X

1. Shut down all applications and open “System Preferences” from the Apple menu.
 2. Open “Sound”.
 3. From the “Output” tab, select “TASCAM US-366”.
- After completing the settings, restart the computer and check the playback sound.

Depending on the application you are using, other device settings might also be necessary in addition to those above.

In particular, since DAW (Digital Audio Workstation) software operates using audio engines that are different from OS settings, confirm the DAW driver settings first after installing the driver for this unit. Check the manuals for the software that you are using for details about how to make these settings.

Please see the manuals for the applications that you are using for detailed setting procedures.

■ The sound breaks up or there is noise.

The processing load on the computer can cause sound to break up and noise to occur.

Some ways to reduce the load on a computer are introduced below.

- 1) If a wireless LAN, antivirus software or other software are running in the background, they regularly use the computer's CPU, and this burden can cause sound to break up and noise to occur.
Stop wireless LAN transmission, antivirus software and other software running in the background when using this unit.
- 2) Try increasing the buffer size (latency) setting in the audio application that you are using and/or in the control panel for this unit.

NOTE

Consult the maker of your audio application for methods to reduce its burden on your computer.

- 3) Change the settings of your computer so that they are optimal for audio processing.

Using Windows

- ① Open the Control Panel using the procedures for the OS (Windows 10 / Windows 8.1 / Windows 7).
 - In Windows 10, click Control Panel from the Windows Start button to open the Control Panel. Then, click the System icon.
 - In Windows 8.1, right-click the ordinary Start screen (Metro user interface screen) and then click “All apps”. Then, right-click “Computer” and select “Properties”.
 - In Windows 7, right-click “Computer” from the Windows Start button, and select “Properties”.
- ② Click “Advanced system settings”.
- ③ Click “Settings” in the “Performance” section of the “Advanced” tab of the “System Properties” window.
- ④ In the “Visual Effects” tab of the “Performance Options” window, select “Adjust for best performance”.

Using Mac

1. Open “System Preferences...” from the Apple menu, and select “Energy Saver”.
2. Set “Computer sleep” to “Never”.
3. Set “Display sleep” to “Never”.

NOTE

Depending on the Mac OS version and model these settings might not be available.

■ The volume is not right.

Mixer functions might be affecting the volume. Check the settings on the “MIXER” page of the Mixer Panel.

■ The sound is strange.

A built-in effect might be changing the sound. Check the settings on the “EFFECTS” page of the Mixer Panel.

■ The volume cannot be adjusted in Audio MIDI Setup (Mac OS).

The knobs on this unit and the controls on the MIXER page are used to adjust this unit's input and output levels. For this reason, adjustment of volume levels is not possible on the Audio Devices screen of the Audio MIDI Setup utility application for Mac.

Use the knobs on the unit and the faders on the MIXER page to make adjustments.

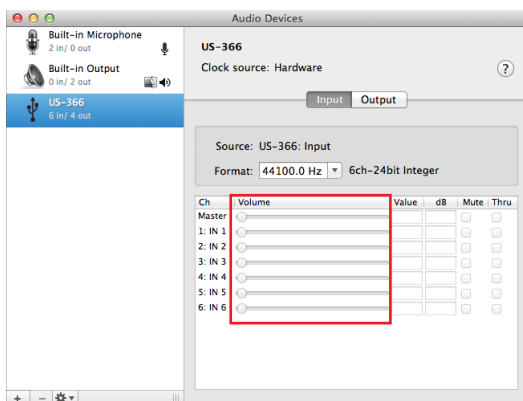

■ Support for Bundled DAW Software

TASCAM does not provide end-user support for the bundled DAW Software. Please check the Help menu of the installed software to find where this support is available.

8 – Specifications

Ratings

Sampling frequency

44.1/48/88.2/96/176.4/192 kHz

Quantization bit rate

24-bit

Analog audio inputs and outputs

Analog audio inputs

Microphone inputs (INPUT 1/L, INPUT 2/R)

Balanced

Connectors: XLR-3-31 equivalent (1: GND, 2: HOT, 3: COLD)

Input impedance: 2.2 k Ω

Nominal input level (**INPUT** knob at maximum): -65 dBu

Minimum input level (**INPUT** knob at minimum): -22 dBu

Maximum input level (**INPUT** knob at minimum): -6 dBu

Line inputs (INPUT 1/L, INPUT 2/R)

Balanced

Connectors: 6.3 mm (1/4") standard TRS jacks

(Tip: HOT, Ring: COLD, Sleeve: GND)

- **INPUT 1/L** when **MIC/LINE-GUITAR** switch set to **MIC/LINE** and **INPUT 2/R**

Input impedance: 15k Ω

Nominal input level (**INPUT** knob at maximum): -39 dBu

Minimum input level (**INPUT** knob at minimum): +4 dBu

Maximum input level (**INPUT** knob at minimum): +20 dBu

- **INPUT 1/L** when **MIC/LINE-GUITAR** switch set to **GUITAR**

Input impedance: 1 M Ω

Nominal input level: (**INPUT** knob at maximum): -55 dBV

Nominal input level: (**INPUT** knob at minimum): -12 dBV

Maximum input level: (**INPUT** knob at minimum): +4 dBV

Line inputs (LINE I/O 3-4)

Unbalanced

Connectors: RCA pin jacks

- When **LINE I/O** switch set to **INPUT**

Input impedance: 15 k Ω

Nominal input level: -10 dBV

Maximum input level: +6 dBV

Analog audio outputs

Line outputs (LINE OUT 1/L, LINE OUT 2/R)

Balanced

Connectors: 6.3 mm (1/4") standard TRS jacks

(Tip: HOT, ring: COLD, sleeve: GND)

Output impedance: 100 Ω

Nominal output level: +4 dBu

Maximum output level: +20 dBu

Line outputs (LINE I/O 3-4)

Unbalanced

Connectors: RCA pin jacks

- When **LINE I/O** switch set to **OUTPUT**

Output impedance: 200 Ω

Nominal output level: -10 dBV

Maximum output level: +6 dBV

Headphones outputs (PHONES)

Connectors: 6.3 mm (1/4") stereo phone jack

Maximum output: 18 mW + 18 mW

(THD+N 1% or less, into 32 Ω)

Digital audio inputs

COAXIAL (DIGITAL IN)

- When **DIGITAL IN** switch set to **COAXIAL**

Connector: RCA pin jack

Format: IEC 60958-3 (S/PDIF)

OPTICAL (DIGITAL IN)

- When **DIGITAL IN** switch set to **OPTICAL**

Connector: TOS (JEITA RC-5720C)

Format: IEC 60958-3 (S/PDIF)

Digital audio outputs

COAXIAL (DIGITAL OUT)

Connector: RCA pin jack

Signal format: IEC 60958-3 (S/PDIF)/IEC 60958 professional (AES/EBU)

(Set on the "INTERFACE" page of the Mixer Panel)

OPTICAL (DIGITAL OUT)

Connector: TOS (JEITA RC-5720C)

Signal format: IEC 60958-3 (S/PDIF)/IEC 60958 professional (AES/EBU)

(Set on the "INTERFACE" page of the Mixer Panel)

Control I/O

USB (USB)

Connector: B-type 4-pin
Format: USB 2.0 HIGH SPEED (480 MHz)

REMOTE input

Connector: 2.5 mm TRS jack
Supported protocol: TASCAM RC-3F protocol

Audio performance

Analog-digital/digital-analog conversion

ADC chipset dynamic range: 102 dB (48 kHz, A-weight)
DAC chipset dynamic range: 106 dB (44.1 kHz, A-weight)

Frequency response

MIC IN to **LINE OUT**
10 Hz – 68 kHz, ± 3.0 dB (176.4/192 kHz, JEITA)
MIC IN to **PHONES**
10 Hz – 30 kHz, ± 1.0 dB (176.4/192 kHz, JEITA)

S/N ratio

98 dB or higher (MIC IN to **LINE OUT**, gain knob at minimum, 176.4/192 kHz, JEITA)

Equivalent input noise

-120 dBu or less (MIC IN to **LINE OUT**, gain knob at maximum, 176.4/192 kHz, JEITA)

Total harmonic distortion

0.0045% or less (MIC IN to **LINE OUT**, gain knob at minimum, 176.4/192 kHz, JEITA)

Computer requirements

See the TEAC Global Site (<http://teac-global.com/>) for updated information about OS compatibility.

Windows

Supported Operating system

Windows 10 32-bit/64-bit
Windows 8.1 32-bit/64-bit
Windows 8.0 32-bit/64-bit
Windows 7 32-bit SP1 or later/64-bit SP1 or later
Windows XP 32-bit SP3 or later/64-bit SP2 or later
(Windows Vista are not supported)

Supported computer system

Windows compatible computer with a USB 2.0 port

CPU/clock

Dual core processor 2GHz or faster (x86)

Memory

2GB or more

CAUTION

This unit has been confirmed to work with standard computers that meet the above system requirements, but this is not a guarantee that it will work with all computers that meet the above requirements. Even if a computer meets the above requirements, its processing abilities will differ according to its unique design specifications and operating conditions.

Mac OS X

Supported Operating system

OS X El Capitan (10.11 or later)
OS X Yosemite (10.10 or later)
OS X Mavericks (10.9 or later)
OS X Mountain Lion (10.8 or later)
OS X Lion (10.7 or later)
OS X Snow Leopard (10.6.8 or later)

Supported computer system

Mac with a USB2.0 port

CPU/clock

Dual core processor 2GHz or faster (x86)

Memory

2GB or more

Supported audio drivers

ASIO2.0, WDM (MME)
Core Audio

Supported remote control protocol

Mackie Control
HUI

8 – Specifications

General

Power

Supplied by USB from a computer (5 V, 500 mA maximum current)

Weight

500 g/1.10 lb

Power consumption

2.5 W

Operating temperature range

5-35°C/41-95°F

External dimensions (W x H x D)

140 x 42 x 140 mm/5.51 x 1.65 x 5.51 in. (without projections)

Dimensional drawing

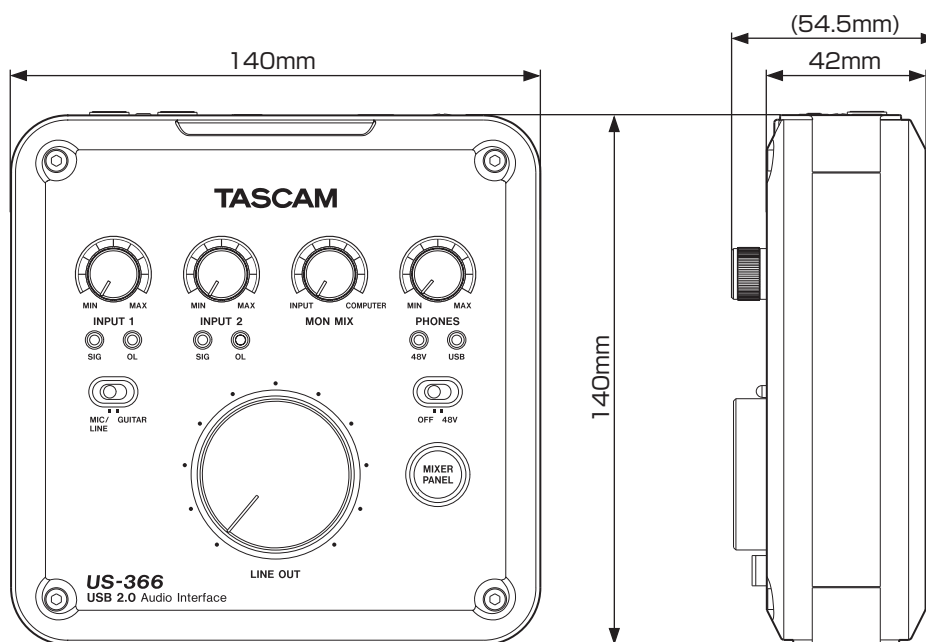

- Illustrations in this manual may differ in part from the actual product.
- Specifications and the external appearance may be changed without notification to improve the product.

8 – Specifications

US-366 Stereo Mix Mode

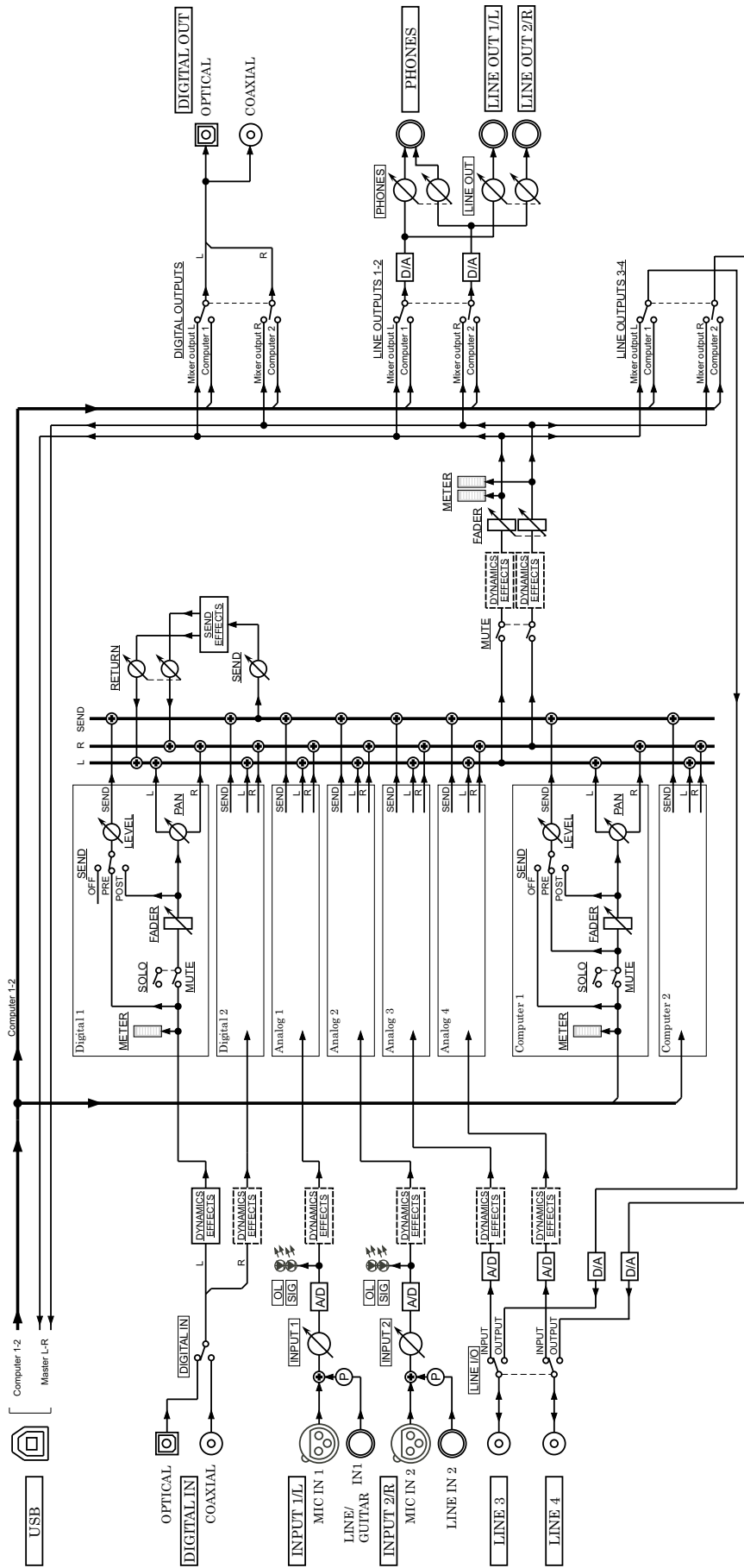

TASCAM

US-366

TEAC CORPORATION

Phone: +81-42-356-9143

1-47 Ochiai, Tama-shi, Tokyo 206-8530 Japan

<https://tascam.jp/jp/>

TEAC AMERICA, INC.

Phone: +1-323-726-0303

1834 Gage Road, Montebello, California 90640 USA

<http://tascam.com/>

TEAC UK Ltd.

Phone: +44-8451-302511

2 Huxley Road, Surrey Research Park Guildford, GU2 7RE, United Kingdom

<http://tascam.eu/>

TEAC EUROPE GmbH

Phone: +49-611-71580

Bahnstrasse 12, 65205 Wiesbaden-Erbenheim, Germany

<http://tascam.eu/>

TEAC SALES & TRADING(SHENZHEN) CO., LTD

Phone: +86-755-88311561~2

Room 817, Block A, Hailrun Complex, 6021 Shennan Blvd., Futian District, Shenzhen 518040, China

<http://tascam.cn/>
